

P-2424

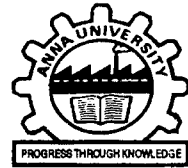

**“ENHANCING THE EFFICACY OF SUPPLY CHAIN  
MANAGEMENT AT MADRAS CEMENTS LTD”**

By

S.VIGNESWARAN

Reg No: 71206631060

Of

Department of Management Studies

**Kumaraguru College of Technology**

Coimbatore

A PROJECT REPORT

Submitted to the

**FACULTY OF MANAGEMENT STUDIES**

In the partial fulfillment of the requirements

for the award of the degree

of

**MASTER OF BUSINESS ADMINISTRATION**

June, 2008



**Department of Management Studies  
Kumaraguru College of Technology  
Coimbatore – 641006**

## **BONAFIDE CERTIFICATE**

This is certified that this project report titled “**Enhancing the efficacy of supply chain management at Madras Cements Ltd**” is the bonafide work of Mr.S.VIGNESWARAN (Reg No. 71206631060) who carried this research under my supervision. Certified further that to the best of my knowledge the work reported herein does not form part of any other project report or dissertation on the basis of which a degree or award was conferred on an earlier occasion on this or any other candidate.

**Prof. R. HEMANALINI**

**PROJECT GUIDE**

**DIRECTOR**

Evaluated and Viva Voce conducted on 03-07-2008

**INTERNAL EXAMINER**

**EXTERNAL EXAMINER**

## DECLARATION

I, hereby declare that this project report entitled as “**Enhancing the efficacy of supply chain management at Madras Cements Ltd**” has been undertaken for academic purpose submitted to Anna University in partial fulfillment of the requirements for the award of the degree of Master of Business Administration. The project report is the record of the work done by me under the guidance of **Prof. R.HEMANALINI** during the academic year 2007 – 2008.

I, also declare hereby, that the information given in this report is correct to best of my knowledge and belief.

Date: 03-07-2008

Place: Coimbatore

*S. Vigneswaran*  
S.VIGNESWARAN

## **EXECUTIVE SUMMARY**

Process integration is a leading aim for many supply-chain managers. Although the benefits of successful process integration are desirable, the barriers are quite daunting. Our study benchmarks the current status of process integration in supply chain management in Madras Cements Limited (MCL) and suggestions to improve the present form using in-depth analyze methodology. The title of the project is 'Enhancing the efficacy of supply chain management at Madras Cements Ltd. The study reveals nine main approaches to process integration dealing with procuring, logistics and distributing. To obtain auxiliary efficiency, in addition to the present competence, Madras cements Ltd., plans to redesign the supply chain, where it's required better improvement in some awful areas. We discuss all of these approaches implications for academics and provide prescriptive direction where research and development should be channeled to facilitate process integration success.

The traditional vision of Supply Chain management (SCM) represents only one dimension of a business environment that is growing increasingly multidimensional. In a typical supply chain, raw materials are procured and items are produced at one or more factories, shipped to warehouses for intermediate storage, and then shipped to retailers or customers. Consequently, to reduce cost and improve service levels, effective supply chain strategies must take into account the interactions at the various levels in the supply chain. The supply chain, which is referred to as logistics network, consists of suppliers, manufacturing centers, warehouses, distribution centers, and retail outlets, as well as raw materials, work in process inventory, and finished products that flow between the facilities.

## **ACKNOWLEDGEMENT**

I express my sincere gratitude to our Correspondent **PROF. DR. K. ARUMUGAM**, the prime guiding spirit of Kumaraguru College of Technology. I extend my thanks to Principal **DR. JOSEPH V. THANIKAL**, Kumaraguru College of Technology, and Coimbatore for providing facilities to do this project. I express my sincere gratitude and thanks to our Director **DR. S.V.DEVANATHAN** for permitting me to carry out this project. I endeavor my gratitude towards my guiding spirit **Prof..R.HEMANALINI** , who has given me all the guidance throughout this project. I extend my sincere thanks and gratitude to **MADRAS CEMENTS LIMITED** for permitting me to do the project. Specially, I would like to thank **MR. M. VIVEK**, HRD Manager of **MADRAS CEMENTS LIMITED**.

## TABLE OF CONTENTS

CHAPTER NO	TITLE	PAGE NO
	<b>EXECUTIVE SUMMARY</b>	iv
	<b>LIST OF TABLES</b>	vii
	<b>LIST OF CHARTS</b>	vii
1	<b>INTRODUCTION</b>	
	1.1 BACKGROUND	1
	1.2 REVIEW O LITERATURE	2
	1.3 OBJECTIVE OF THE STUDY	4
	1.4 STATEMENT OF THE PROBLEM	5
	1.5 SCOPE OF THE STUDY	6
	1.6 THEORETICAL CONCEPTS	7
	1.7 RESEARCH METHODOLOGY	8
	1.8 TYPE OF STUDY	9
	1.9 TOOL FOR ANALYSIS	9
	1.10 LIMITATIONS	10
2	<b>ORGANISATION PROFILE</b>	
	2.1 HISTORY OF THE ORGANISATION	11
	2.2 THE MISSION	12
	2.3 OPERATIONAL HIGHLIGHTS	12
	2.4 RESOURCE UTILIZATION	14
	2.5 ARRANGEMENTS FOR ZERO ACCIDENT IN PLANT	14
	2.6 OVERALL CEMENT PRODUCTION PROCESS	15
	2.7 DISTRIBUTION SYSTEM	17
3	<b>MACRO-MICRO ANALYSIS</b>	18
4	<b>DATA ANALYSIS AND INTERPRETATION</b>	22
5	<b>CONCLUSION</b>	54
	BIBLIOGRAPHY	58

## LIST OF TABLES

TABLE NO	TITLE	PAGE NO
1.1	Region wise demand forecast for 2008-2009	19
1.2	Regional distribution of capacity and production	20
1.3	Major cement players in India	21
4.1	Interlinking distribution	30
4.2	Quality testing	39
4.3	Milk run distribution	46

## LIST OF CHARTS

CHART NO	TITLE	PAGE NO
1.1	Demand cycle	19
1.2	Demand drivers	20
4.1	Interlinking distribution	30
4.2	Gantt chart for loading and unloading of limestone	34
4.3	Gantt chart for internal logistics	36
4.4	Quality testing	39
4.5	Gantt chart for quality testing	39
5.1	Distribution of logistics cost	54

## **CHAPTER-1**

### **INTRODUCTION**



## **CHAPTER-1**

### **INTRODUCTION**

#### **1.1 BACKGROUND**

The cement industry presents one of the most energy-intensive sectors within the Indian economy and is therefore of particular interest in the context of both local and global environmental discussions. Increases in productivity through the adoption of more efficient and cleaner technologies in the manufacturing sector will be effective in merging economic, environmental, and social development objectives. A historical examination of productivity growth in India's industries embedded into a broader analysis of structural composition and policy changes will help identify potential future development strategies that lead towards a more sustainable development path.

India is the **second largest** producer of cement behind china. The per capita consumption of cement in India is 110 kg and is only about the third of the world average indicating the growth potential for this sector. The Indian cement industry is a mixture of mini and large capacity cement plants, ranging in unit capacity per kiln as low as 10 TPD to as high as 7500 TPD. Majority of the production of cement in the country (94%) is by large plants, which are defined as plants having capacity of more than 600 TPD. At present there are 124 large rotary kiln plants in the country. The top five players in the industry were accounts for 46% of total capacity.

## **1.2 REVIEW OF LITERATURE**

Adoption of SCM practices in industries has gradually increased since the 1980s. A number of definitions are proposed and the concept is discussed from many perspectives. However, Amit and Subhash (2005), John e al. (2006) and Paul et al. (2006), have provided excellent review of SCM literature. These papers define the concepts, principles, nature and development of SCM and indicate that there is an intense research being conducted around the world in this field. They critically assessed the developments in the theory and practice of supply management and through such an assessment identified the barriers and enablers. The authors found gap in theory and practice and explored he future research areas.

Michael and Joel (2001) determined the scope of processes that are being integrated across organizational border and indicated that a large number of companies hat practice SCM are attempting to integrate logistics, marketing, and operations oriented processes across supply chains.

Gunasekaran and Ronald (2003) extended the scope of SCM beyond material management, partnership, information technology to the TQM areas such as management commitment, organization structure, training and behavioral issues. As firms' survival lies on integration, a good understanding of the integration process is a key aspect in SCM.

Wann- Yih Wu et al. (2004), and Peter and Jianwen (2006) studied how to integrate the SCM business process. It is concluded that the level of investments to supply chain partners, the degree of dependence between supply chain partners, and the level of product salability of manufacturer would enhance commitment and, consequently, the integration of the SCM business process. It is concluded that the level of investments to supply chain partners, the degree of dependence between supply chain partners, and the level of product salability of manufacturer would enhance commitment and consequently, the integration of the SCM business process.

Hakan and Goran (2004) provided a theoretical framework and proposed the theoretical as well as empirical reasons for enhancing the underlying logic of process integration in SCM to capture the pooled and reciprocal interdependencies.

Jan et al. (2003) discussed that the basic hypothesis “the more integration (wider the scope) - the better the management of the chain” is not always true and proved that it depends very much on the ‘environment’ of the supply chain and the power relations between the participants in the supply chain.

Cigolini et al. (2004) and Siddharth et al. (2006) discussed strategy formulation, and identified decision- making areas for improving material flow, and finally performance evaluation in order to determine how well the supply chain initiative has been implemented.

The authors proposed a set of management techniques and tools to analyze successful SCM strategies.

Rajesh and Yonghui (2005) presented a coordination framework called Advanced System for Communication and Education in National Development (ASCEND) to align the inventory decisions in decentralized supply chains. The framework was based on multi-agent technology, coordination theory, and optimization technology.

### **1.3 OBJECTIVES OF THE STUDY**

The project was done on the title 'Enhancing the efficacy of supply chain management at Madras cements ltd.'

#### **Primary objective**

- Implement the effective SCM concept, focusing particularly on the activities like storage, distribution and transportation of finished product to the end user.
- Reduce inventory cost, Improve efficiency and quality of the manufacturing process by optimizing the material distribution and dispatching.

#### **Secondary objective**

- Increase sales by Reducing logistics and transportation costs by moving the material to right place at the right time..
- Interlink and synchronize the activities carried out by the organization. Effective scheduling and routing of the task carried out in the company.
- Improve the coordination and the collaboration with suppliers, manufacturers and distributors.

#### **1.4 STATEMENT OF THE PROBLEM**

Madras Cements Ltd. has its full-fledged supply chain to store and transport their materials, but by the research done by their research department identify that the cost spent on distribution and logistics will create a major impact in their expenditure, the organization plans to enhancing the supply chain of this particular plant. Hence a study was needed in the analysis of the lagging areas in the whole logistics and the measures require correcting it.

From the logistic viewpoint, the management of supply chains involves a set of complex and interdependent combinatorial problems (e.g. acquisition of raw materials, scheduling of production facilities, routing of transport vehicles, etc.). Each of the mentioned logistic problems suffers from a nearly prohibitive combinatorial complexity, even when considered as independent from the other ones. So the study was conducted to analyze the logistics and the distribution in this particular plant and to recommend the company about the measures to be taken to enhance their opportunity in the market.

## **1.5 SCOPE OF THE STUDY**

- This study deals about the planning of effective supply chain by analyzing and prevail over the limitations present in the present system and scheduling the task in
- It also depicts the effectiveness of procurement and transportation of materials from one place to the other through good warehousing and stock control.
- It improves collaboration between all participants of the supply chain - suppliers, manufacturers and distributors.
- Maximize the utilization of resources, minimize its costs by streamlining and optimizing the supply chain from demand forecasting, materials requisition, order processing, order fulfillment, transportation services, receiving, invoicing, and payment processing.
- It utilized to facilitate the coordination with outside business entities, or in the scope of extended enterprise.

## 1.6 THEORITICAL CONCEPTS

Supply chain management is the combination of the enterprise strategies, business process and information technologies that integrates the suppliers of raw materials or components, the manufacturers or assemblers of the finished products, and distributors of the products or services into one cohesive process to include demand forecasting, materials requisition, order processing, order fulfillment, transportation services, receiving, invoicing, and payment processing.

### Processes of Supply Chain Management

- **Demand Planning and Forecasting** - Accurate demand forecasting is considered one of critical success factors in supply chain management. The accuracy of the demand forecasting is largely dependent on how abnormal data is treated in the demand forecasting. Demand forecasting is an ongoing process.
- **Procurement** - This is the process of choosing the suppliers that will deliver the goods and services you need to manufacture or assembly your products or to create your services. It involves price negotiation, receiving, and verifying the shipments.
- **Manufacturing and Assembly** - Raw components are assembled into final products or raw materials are manufactured into finished goods. Manufacturing involves the activities of production, testing, packaging and preparation for delivery.
- **Distribution** - Products or services are delivered to consumers. Distribution involves warehousing, delivering, invoicing and payment collection.
- **Return** - Return and refund are important parts and also the problem parts of supply chain management. The organisation should have infrastructure in place for receiving defective and excess products back from customers.

## **1.7 RESEARCH METHODOLOGY**

Research in common parlance refers to a search for knowledge. One can also define research as scientific and systematic search for pertinent information on a specific topic. In fact research is an art of science investigation.

The advanced Learner's Dictionary of current English lays down the meaning of research as "A careful investigation or enquiry specifically through search for new facts in any branch of knowledge"

Red man and money define research as a "Systematized effort to gain new knowledge".

A research cannot be conducted abruptly. Researcher has to proceed systematically in an already planned direction with the help of a number of steps in sequences. To make the research systemized the researcher has to adopt certain methods. The method adopted by researcher for completing the project is called Research Methodology.

In other words, Research Methodology is simply the plan of action for a research which explains in detail how data is to be collected, analyzed and interpreted. Data become information only when a proper methodology is adopted. Thus we can say Methodology is a tool which processes the data to reliable information. This chapter attempts to highlight the research methodology adopted in this project.



## 1.8 TYPE OF STUDY

The research design used in the study is descriptive research design. A descriptive study is undertaken in order to ascertain and able to describe where scm can be implemented in the company effectively. Descriptive studies that present data in a meaningful form thus help to

1. To understand the characteristics of a area in a given situation,
2. To think systematically about aspects in a given situation,
3. To offer idea for further probe and research and
4. To help to make certain simple decisions.

## 1.9 TOOL FOR ANALYSIS

**Gantt chart**-it can be characterized as given below

- A set of multiple operations is available for processing at time zero(each process requires  $M$  operations and each operation requires a different machine)
- Set up times for the operations are sequence independent, and are included in processing times.
- Job descriptors are known in advance.
- $M$  different machines are continuously available.
- Each individual operation of jobs is processed till its completion without break.

## **1.10 LIMITATIONS**

Though the study is descriptive and analytical it involved the following limitations:

1. Analysis and interpretation are made based on the figures given in the records only.
2. The reliability and accuracy of calculation depends on the accuracy of information found in data available.

## **CHAPTER – 2**

### **ORGANIZATION PROFILE**

## **CHAPTER-2**

### **ORGANIZATION STUDY**

#### **2.1 Madras Cement Ltd...**

**Madras Cement Limited** was the most ambitious diversification of the Ramco Group. Madras Cements Ltd is a Public Limited Company managed by Board of Directors under the dynamic leadership of Shri. P.R. Ramasubrahmaneya Rajha as Chairman and Managing Director, ably supported by a team of experts in Cement Technology, Mining operations, Marketing Techniques, Finance, Administration, HRD etc.

It was incorporated in 1957 with the aim of installing two wet process cement kilns at RamasamyRaja Nagar in the industrially backward Virudhunagar District. The commercial cement production started in 1961. The Company's principal activity is to produce blended cement, ready-mix concrete and dry mortar mix. The Company also generates power from windmills. The Company has a research and development center in Thuraiyakkam, Chennai. The Company has Cement Division in TamilNadu, Andhra Pradesh and Karnataka, Ready-mix Concrete Division in Chennai, Ramco Wind Farm Division in Kanyakumari District and Coimbatore District, Dry Mortar Division in Kanchipuram District. Today, Ramco is a vibrant group of companies aggregating an annual turnover of about Rs.1500 Crores. Madras cements limited manufactures and markets its cement under the brand of Ramco cements. MCL is an ISO-9002 company.

## 2.2 The Mission

- To continuously improve productivity through quality, technology renewal and customer focused operations.
- To position ourselves in the cement business as a pace setter and grow in the same and related business.
- To seek green field locations for growth on the basis of developed synergies of the existing operations.
- To continuously seek quality enhancement in product, processes and responses to various stakeholders.
- To update management practices on a continuous basis and maintain a culture of professional management.
- To conserve, protect and enhance quality of life for our employees and community.
- To preserve the credence in our motto "our real resources are the human assets".

## 2.3 OPERATIONAL HIGHLIGHTS

<i>Cement Capacity</i>	<i>: 6 MTPA</i>
<i>Sales Turn Over</i>	<i>: 1169 Crores</i>
<i>Fixed Assets</i>	<i>: 1641 Crores</i>
<i>Cement Factories</i>	<i>: 4</i>
<i>No of Employees</i>	<i>: 1800</i>
<i>Wind Farm Capacity</i>	<i>: 45 MW</i>

- **Pioneer** in Cement technology.
- **Sixth largest** Cement Producer in India.
- **Single largest** Cement Brand in South.
- **Sophisticated R&D** Centre in Chennai.

Madras Cements, with a total capacity of nearly 6 MT (million tons) controls almost 14% of the total cement capacity in the southern region. The company has not looked beyond the southern markets to diversify geographically, which is a useful strategy for a commodity business like cement.

Madras cements limited is a pioneer in the computerization of operations. A **Management Information System (MIS)**, designed by the in-house team was installed at every stage of manufacture and service functions, right from receipt of an order to completion of the transaction i.e. up to effective monitoring of payments. The company has installed **Enterprise Resource Planning (ERP)** software which will link all the sales locations spread all over India to the factory locations at three different places and also the corporate office at Chennai. This system will re-engineer the operations to ensure more effective customer service and better inventory management.

Madras Cements Ltd operates four ultra modern production facilities with a total capacity of 6 million tons per annum.

- R R Nagar, Tamil Nadu (1.2 MTPA)
- Jayanthipuram, Andhra Pradesh (1.6 MTPA)
- Alathiyur, Tamil Nadu (3.0 MTPA)
- Method, Karnataka (0.2 MTPA)

R R Nagar Plant was setup near virudhunagar in TamilNadu in 1961, marked one of the India's first technologically advanced, cleanest and most efficient cement units. It started as a wet process plant of 500 TPD capacities. The plant commissioned the first 1200 TPD dry plant in 1976 and installed electro static precipitator in 1976 for first time when there were no stronger norms for emissions. Also an X-Ray analyzer for quality control was installed for the first time in South Indian Cement Industry.

The present capacity of the plant is 1.1 Million tons per annum. The present number of employees working in this unit is about nearly 400 and the major customers for the product produced in this plant are spread all over the **south TamilNadu and south Kerela**. Nearly 60% of the dispatched cement is delivered to Kerela and the remaining 40% is delivered to the south TamilNadu.

## **2.4 RESOURCE UTILIZATION**

The plant has taken various initiatives for Resources Conservation, minimizations and Effective utilizations at various levels.

Some of salient features are:

- Implemented the powerful ERP (Entrepreneurs Resource Planning) system, which helps us in planning at each level.
- Pet coke a refinery waste enables us to use our low grade limestone ( $\text{SiO}_2$  - 16 to 20 %) about 1.5 Lac tones / Annum, which indeed extends the life of our mines.
- Power plant waste Fly ash is being used for blended cements.
- Waste oil generated from our heavy equipments at Mines is being reused in our conveying equipments (Drag Chains) at our LSS (Limestone storage shed, Coal storage shed and Additive storage shed)
- The colony generated Sewage is treated in the STP (Sewage treatment plant) and recycled to our colony for gardening purposes.
- Bio waste fuels such as cashew shell; Ground nut shell is being used as alternative fuels.

## **2.5 ARRANGEMENTS FOR ZERO ACCIDENT IN PLANT.**

- Employees should wear safety shoes and helmets in the plant.
- The plant has safety & fire protection equipments.
- Safety audits are conducted by (Internal) safety committee members.
- An external auditor inspects the plant for safety measures implemented in the plant and report for improvements.
- A hospital is arranged in colony to meet any emergencies.

Safety interlocks provided for each equipment in the computerized plant operating system. This ensures accident free operation in the plant.

## **2.6 OVERALL CEMENT PRODUCTION PROCESS**

The cement production process is mainly alienated in to 4 processes:

They are

- **Drying and Raw Grinding**
- **Kiln Burning and Cooling**
- **Packing**
- **Finish Grinding and**
- **Quality Control**

### **DRYING AND RAW GRINDING**

Raw materials are dried in rotary dryers using waste heat from the kiln. The moisture content is greatly reduced to improve quality control and handling. The dried materials are mixed and fed to raw grinding mills to produce "raw meal". During the process of grinding, samples are tested half-hourly through X-ray analyzers to ensure consistent raw meal quality. The blended raw meal is delivered into storage silos.

### **KILN BURNING AND COOLING**

Blended raw meal is transported by pneumatic conveyors to the kiln's suspension pre-heaters where it is preheated to achieve a high degree of calcinations (oxidization of the calcium carbonate) before the raw meal enters the rotary kiln. In the rotary kiln, the preheated raw meal is completely calcined and finally sintered at 1,450 C to form clinker. Hot clinker from the rotary kiln is discharged onto coolers where it is quenched and cooled by fresh air from high capacity fans. The air that passes through the clinker layer is thereby heated and is subsequently used as combustion air in the kiln. Cooled clinker is delivered to clinker silos



## FINISH GRINDING

From clinker silos, the cooled clinker is mixed with gypsum and fed into the grinding mill to produce cement. The finished cement is then pumped into cement silos.

## PACKING

Cement is transferred from the storage silos to the packing plant for bag and bulk loading. Bagging is done by high speed in line and rotary packing machines. Filled bags are automatically weighed, sealed and loaded onto trucks by conveyor belt. The total combined rated capacity of all Indocement's packing machines is 5,000 tons per hour. Bulk cement is loaded into special tank trucks for delivery to customers' portable silos at construction sites or is trucked to Indocement's port facilities.

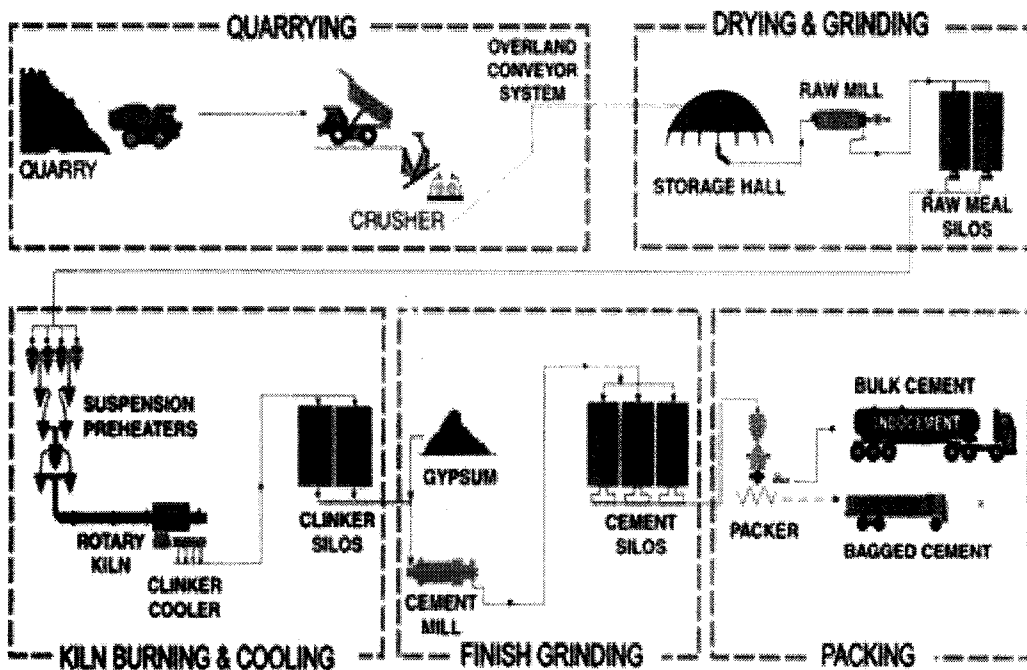

## QUALITY CONTROL

The production process at each of plant is monitored by the particular plant's individual and centralized control room where computerized equipment is used to monitor the entire process from raw materials at storage to grinding of cement at the finish mill. Cement quality checks are carried out continuously. To ensure the production of consistently high quality cement, a modern system of automatic samplers, automatic X-ray analyzers and process computers perform on-line control on the proportioning of raw materials to maintain consistent chemical composition of the cement produced.

## 2.7 DISTRIBUTION SYSTEM

The domestic market domain of M/S. Madras Cements covers south part of TamilNadu and Kerela. About 95 percent of the product is distributed by road transportation in bags and bulk, and the rest using rail transportation in bags and bulk. The cement distributed through land is packed in the packing plant in the factory area. The distribution chart for cement distribution is shown in the figure below.

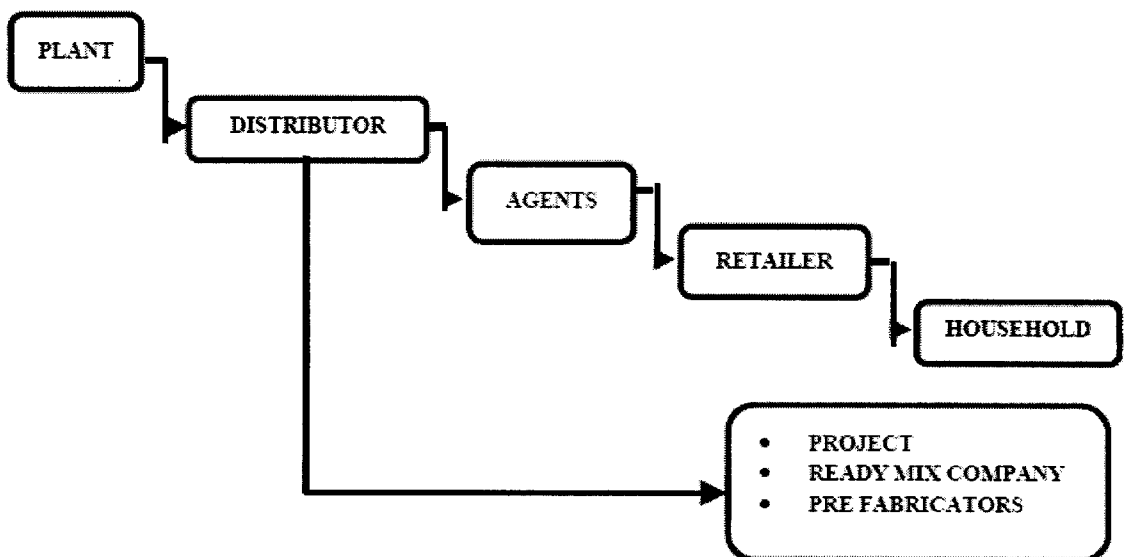

## **CHAPTER – 3**

# **MACRO AND MICRO ANALYSIS**

## **CHAPTER-3**

### **MACRO AND MICRO ANALYSIS**

#### **3.1 Macro Analysis**

##### **Power intensive industry**

Cement is a power intensive industry requiring 110 to 120 units of power per ton of cement produced. Significantly power accounts for 15-20 percent of the variable cost of manufacture. Each stage of manufacturing process- raw material grinding, kiln rotation and clinker grinding accounts for roughly one-third of total power consumption. Electricity and coal account for as much as 60-70% of the manufacturing cost of the domestic cement sector, with electricity alone accounting for 40% of the cost.

##### **Demand Cycle (1983 - 2012)**

The demand cycle for the cement is separated in to 3 phases, according to year. The phase 1 period is from 1983 to 1991, and in this year the demand is led by government for infrastructure spending and public spending. The phase 2 periods is from 1991 to 2006, and in this year the demand is led by private sector for primarily residential and IT. The phase 3 periods is starts from 2006, and in this year the demand is led by infrastructure and commercial and also government trust with public-private partnership for commercial malls and special economic zone.

## 1.1 Demand cycle

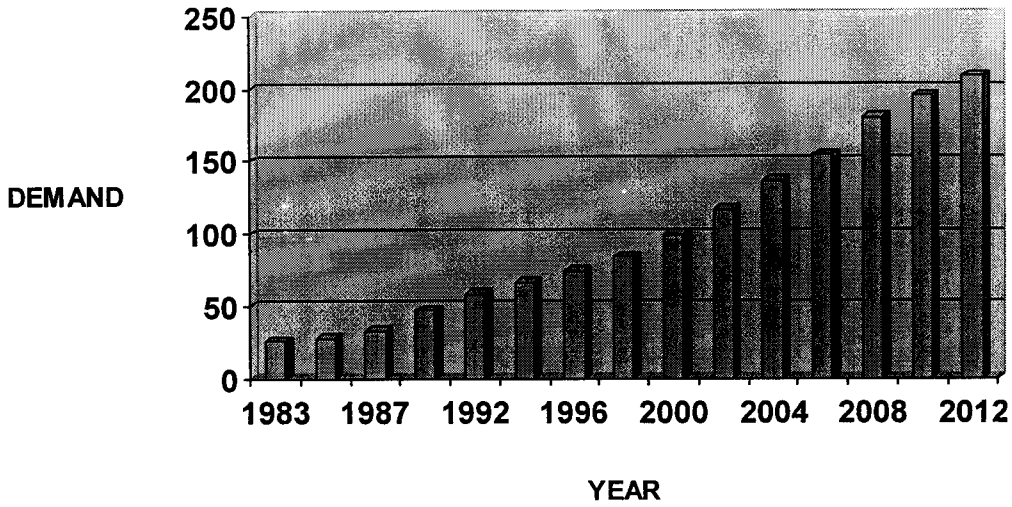

## 1.1 Region wise Demand forecast for 2008-2009

Region	% of all India market	Demand forecast in million tons
North	20	36
East	17	31
Central	15	27
West	18	34
<b>South</b>	<b>30</b>	<b>55</b>
Total	100	183

## 1.2 Regional Distribution of Capacity and Production

FY	Million tonnes			Share of total		
	2004	2005	2006	2004	2005	2006
<b>Capacity</b>	<b>144.30</b>	<b>151.34</b>	<b>157.15</b>	<b>100</b>	<b>100</b>	<b>100</b>
North	25.97	27.36	29.59	18.0	18.1	18.8
East	22.38	22.81	22.85	15.5	15.1	14.5
South	46.27	48.06	50.76	32.1	31.8	32.3
West	27.98	28.92	28.94	19.4	19.1	18.4
Central	21.70	24.20	25.00	15.0	16.0	15.9
<b>Production</b>	<b>117.50</b>	<b>127.57</b>	<b>141.81</b>	<b>100</b>	<b>100</b>	<b>100</b>
North	25.22	26.70	30.17	21.5	20.9	21.3
East	16.67	18.73	19.54	14.2	14.7	13.8
South	36.13	38.98	44.88	30.8	30.6	31.7
West	21.00	22.76	24.93	17.9	17.8	17.6
Central	18.48	20.39	22.28	15.7	16.0	15.7

### Demand drivers

Cement demand is derived from housing, infrastructure and industrial sector. Housing sector is the largest consumer of cement in the country, accounting for about 65% of the total consumption and will continue to remain a major contributor to cement demand. This is largely due to the various financial sops given to this sector in the successive Union Budgets. The housing sector is followed by infrastructure sector (20%) and industrial sector / commercial projects (15%).

### 1.2 Demand Drivers

Domestic Demand Breakup

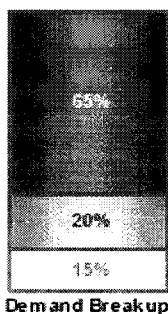

<b>Residential</b> <ul style="list-style-type: none"> <li>• Core demand</li> <li>• Leading growth driver</li> </ul>
<b>Infrastructure</b> <ul style="list-style-type: none"> <li>• Government/Public/Private</li> <li>• Infrastructure gaining importance</li> <li>• Laggard in the past – dependent on fiscal situation and private initiatives</li> </ul>
<b>Commercial / Industrial</b> <ul style="list-style-type: none"> <li>• Emerging growth sector</li> </ul>

### 3.2 Micro Analysis

#### Different varieties of cement

India is also producing different varieties of cement like Ordinary Portland Cement (OPC), Portland Pozzolana Cement (PPC), Portland Blast Furnace Slag Cement (PBFS) and some special cement including Oil Well Cement, Rapid Hardening Portland Cement, Sulphate Resisting Portland Cement, and White Cement etc. Production of these varieties of cement conform to the BIS Specifications. Also, some cement plants have set up dedicated jetties for promoting bulk transportation and export.

#### Production rates of different varieties of cement

Ordinary Portland cement (OPC)	: 44%
Portland Pozzolana Cement (PPC)	: 47%
Portland Blast Furnace Slag Cement (PBFS)	: 8%
Special cements	: 1%

### 1.3 MAJOR CEMENT PLAYERS IN INDIA

#### Major Players in Indian Cement Industry

Thousand tonnes

	FY2005		FY2006	
	Installed Capacity	Production	Installed Capacity	Production
ACC	18,228	16,606	18,640	17,902
Gujarat Ambuja	14,570	14,467	14,860	15,094
Ultratech	17,000	12,921	17,000	13,707
Grasim	14,115	13,143	14,115	14,649
India Cements	8,810	8,506	8,810	8,434
JK Group	6,415	5,769	6,680	6,174
Jaypee Group	5,600	5,429	6,531	6,316
Century Textiles	5,900	6,070	6,300	6,636
Madras Cements	5,470	3,663	5,470	4,550
Birla Corp.	4,780	5,017	5,113	5,150
Lafarge	5,000	4,391	5,000	4,573
Others	45,456	33,589	48,627	38,620
Total	151,344	127,571	157,146	141,805

## **CHAPTER-4**

# **DATA ANALYSIS AND INTERPRETATION**



## **CHAPTER-4**

### **DATA ANALYSIS AND INTERPRETATION**

#### **4.1 SUPPLY CHAIN MANAGEMENT FOR MCL**

**The principle of SCM is the synchronization and coordination of the activities related to the flow of materials and products both within the organization and outside the organization.**

#### **CONCEPT OF SUPPLY CHAIN MANAGEMENT**

The principle of SCM is the synchronization and coordination of the activities related to the flow of materials and products both within the organization and outside the organization. The flow of materials and products need the involvement of all parties in the supply chain. Traditionally, the practice within the organization is for the different departments to work in isolation, under the respective department's own standard. However the SCM concept requires all departments to work together as a cross functional team.

The synchronization of activities is not only internally within the organization, the SCM approach also recognizes that many of the business activities in an organization must be performed based on cooperation with outside parties. Different writers proposed various definitions of SCM, but generally, it can be defined as the synchronization of processes from manufacturing to the delivery to the consumers such that the consumers are satisfied. The consumers in the SCM concept are "kings" and must be served as well as possible. The SCM principle is to win the consumers / end users to the product. The parties in the supply chain must work hard with each other to increase the service level and provide low price for the product.

## VISUALIZING THE SUPPLY CHAIN

The term *supply chain* implies movement of products from suppliers to manufacturers to distributors to retailers to customers along a chain. The term may also imply that only one enterprise is involved at each stage. In reality, a manufacturer will receive material from several suppliers and then, in turn, supply several distributors. Therefore, most supply chains are actually networks. So it would be more accurate to use the term *supply network* or *supply web*.

### 4.2 SCM VARIABLES

The research done on several markets concluded that implementing SCM is essential for the company to survive. In arriving at that conclusion, the market research examined several variables. They are as follows:

- ***The perception variable.*** All variables related to perception by the customers, and marketing such as the image of the product, price, place, promotion, delivery, etc. were analyzed.
- ***The product itself.*** Variables such as the strength of the product, the color of the product, the lifespan of the product, the packing, the type of bags used, the durability of the bags, as well as the trade mark and logo were examined.
- ***The delivery variable.*** Variables studied under this area are the availability of product in the market, accurate quantity and quality of product delivered, speedy and timely arrival of the product after being ordered, and the mode of transportation used.
- ***The price variable.*** The areas examined are competition from foreign producers, cost of production, demand from the market, etc.

## **CHALLENGES OF BUILDING EFFECTIVE SUPPLY CHAINS**

- Develop a strong **supplier base**
- Improve efficiency and quality of the **manufacturing process**
- Reduce **logistics and transportation** costs
- Develop efficient **distribution channels**
- Promote **information exchange** along the supply chain

## **INTEGRATED PLANNING**

Based on the above objectives, and unpredictable changes in the business environment, as well as the results of the market research conducted, MCL tries to implement the SCM concept, focusing particularly on the activities like storage, distribution and transportation of finished product to the end user. The integration and coordination of these activities are as follows:

### ***Marketing Plan***

The team in the Marketing Plan calculates the market demand by forecasting cement demand growth based on economic growth and market share index. The data for the supply plan is plotted further according to distribution, which means the marketing plan, is in a package with the distributor's plan.

### ***Production Plan***

The Marketing department brings its supply plan to the production, utility, technique, and logistics departments and sits together to discuss that plan. The synchronization of the activities is done to meet the market demand in terms of quantity, type, packing and the delivery schedule.

### ***Execution of Delivery***

In executing the delivery, the Marketing department arranges the schedule for the arrival, loading, and departure of the Lorries that will carry the cement to the market. For example, for delivery using road transport (truck), the company uses the software to expedite the loading of cement into the truck. Distribution and transportation management need regular monitoring. If there are changes, these changes need to be synchronized with internal and external parties (agents) again.

### ***Warehouse Management***

The distributors will deliver the product to the retailers and sometimes even up to the end users (i.e. to the project site). From the warehouse, the product is delivered direct to the customers. Synchronization and coordination of all parties must be continuously kept within the supply chain so that there is always sufficient stock maintained in the market.

### ***Information System***

The company relies on the Internet to communicate with their employees and with all marketing representatives. However, not all suppliers have the Internet facility and so relying on this method of communication may not always be possible and feasible.

### **4.3 PROBLEMS ADDRESSED BY THE SUPPLY CHAIN MANAGEMENT**

- **Distribution Network Configuration:** Number and location of suppliers, production facilities, distribution centers, warehouses and customers.
- **Distribution Strategy:** Centralized versus decentralized, direct shipment, Cross docking, pull or push strategies, third party logistics.
- **Information:** Integrate systems and processes through the supply chain to share valuable information, including demand signals, forecasts, inventory and transportation etc.
- **Inventory Management:** Quantity and location of inventory including raw materials, work-in-process and finished goods.

### **SCM & LOGISTICS COSTS METHODOLOGY**

SCM and logistics costs can be broken down in three separate, but complementary pieces: internal costs, outsourcing costs and inventory carrying costs. Each one is described below, with its methodology.

**TOTAL SCM & LOGISTICS COSTS = INTERNAL COSTS + OUTSOURCING COSTS + INVENTORY CARRYING COSTS**

#### **INTERNAL COSTS:**

Internal SCM and logistics cost encompass all logistics activities that occur within a firm, such as a manufacturer, wholesaler or retailer. It excludes all outsourced logistics activities and all production process.

## **OUTSOURCING COSTS:**

Outsourcing costs encompass activities assigned to a third-party. Outsourcing costs come from input-output tables indicate how much each industry requires of the production of each other industry in order to produce each dollar of its own output by compiling the purchases of logistics services by users.

## **INVENTORY CARRYING COST:**

One of the elements comprising a company's total supply chain management costs. These costs consist of the following:

- 1) *Opportunity Cost:*** The opportunity costs of holding inventory. This should be based on your company's own cost of capital standards using the following formula.  
Calculation:  $\text{Cost of Capital} \times \text{Average Net Value of Inventory}$
- 2) *Shrinkage:*** The costs associated with breakage, pilferage, and deterioration of inventories. Usually pertains to the loss of material through handling damage, theft, or neglect.
- 3) *Insurance and Taxes:*** The cost of insuring inventories and taxes associated with the holding of inventory.
- 4) *Total Obsolescence for Raw Material, WIP, and Finished Goods Inventory :*** Inventory reserves taken due to obsolescence and scrap and includes products exceeding the shelf life, i.e. spoils and is no good for use in its original purpose (do not include reserves taken for Field Service Parts).
- 5) *Channel Obsolescence:*** Aging allowances paid to channel partners, provisions for buy-back agreements, etc. Includes all material that goes obsolete while in a distribution channel. Usually, a distributor will demand a refund on material that goes bad (shelf life) or is no longer needed because of changing needs.
- 6) *Field Service Parts Obsolescence:*** Reserves taken due to obsolescence and scrap. Field Service Parts are those inventory kept at location outside the four walls of the manufacturing plant i.e., distribution center or warehouse.

#### 4.4 CEMENT PRODUCTION SUPPLY CHAIN

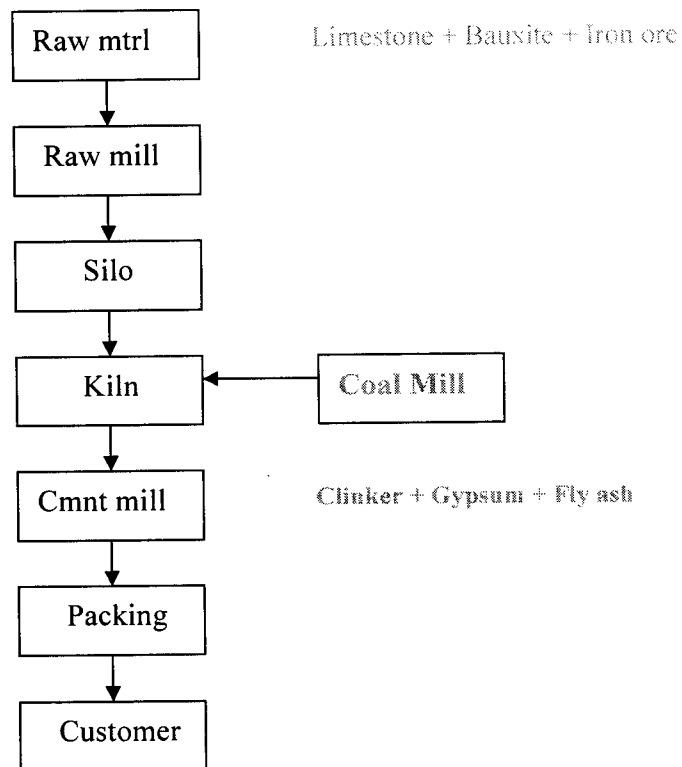

## **4.5 SCM IMPLEMENTING AREAS IN MCL**

The effective handling of SCM at MCL is expected to yield some advantages. First, there is an increase in market share in the area where the supply chain is covered.

### **4.5.1 AREA 1-DISTRIBUTING CEMENT TO SUPPLIERS**

#### **SCM FOR RAW MATERIAL SUPPLYING AND DISTRIBUTION IN MCL**

MCL has its own Limestone quarry in Pandhalkudi, which is 20 kilometers through their own laid road for their personal use from cement plant. The surface miner as the name indicates mines the surface of the limestone deposit through scraping and picking action. The scraped material is conveyed through a boom conveyor attached to miner on to dumper. This dumpers transport the mined low grade limestone to crusher section. There is a set of primary and secondary crushers, which crushes the limestone to the required size for further grinding. The limestone is then further transported through 15 trucks, each of capacity 10 tons. The 80% grade is used for the purpose of producing raw meal, the remaining graded (below 80% and above 80%) are stored separately in the storing place inside the plant.

#### **INTER LINKING DISTRIBUTION**

Quantity of limestone required per year	= 1323855 tons		
Quantity of limestone required per day	= $1323855/365$		
	= 3627 tons		
Percentage of lime stone outsourced	= 20		
Quantity of lime stone outsourced	= 725.4 tons		
Capacity of a single truck	= 10 tons		
Number of trucks receiving per day	= $725.4 / 10$	= 72.541	= 73 approx



#### 4.1 INTERLINKING DISTRIBUTION

South Kerela	South Tamil Nadu	Towards North	Nearest areas
30 %	25 %	18 %	27 %

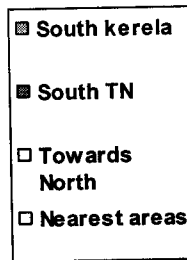
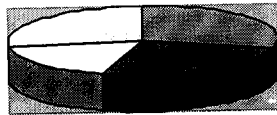

#### 4.1 INTERLINKING DISTRIBUTION

**PRESENT APPROACH:** The company use lend trucks to supply the finished cement products. During the harvesting period and season time like year ending and diwali, the demand for the trucks gets increased. This situation increase the supplying cost because of the third party demand, who lending trucks to company.

**SCM APPROACH:** Number of trucks importing lime stones from those distributing areas is approximately 7 per day. By using those 7 trucks for distributing cement with box packing from the cement plant to supply the finished cement to those areas in which trucks is going to return.

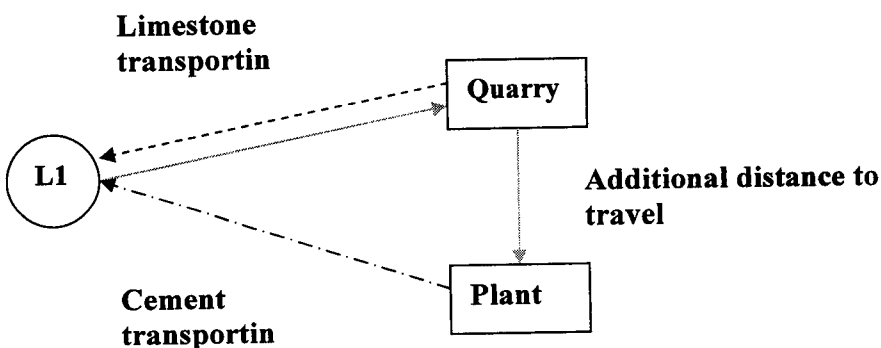

**BENEFITS:** The need for spending amount for transporting cement using other new trucks gets minimized to great extent.

## 4.5.2 AREA 2- LOADING AND UNLOADING LIMESTONE

**PRESENT APPROACH:** The present technique followed by MCL is that they switching the conveyor belt according to the grade in the truck. But it leads to power loss for switching the conveyor and also increase the waiting time of trucks.

**SCM APPROACH:** By calculating the number of trucks uploading 80% graded limestone per day, less than 80% graded limestone and greater than 80% graded limestone and finding the probability that the equal graded limestone are transported to cement plant on a full day.

**BENEFITS:** This minimizes the conveyor switching cost and waiting time. The 3 phase induction DC motor with variable speed used to run the conveyor belt consumes power up to large level. And also the waiting time for trucks to unload the limestone present in it get minimized or some times no need to wait, hence just about 14 trucks are used to transporting lime stone.

**The schematic diagram of Limestone loading and unloading.**

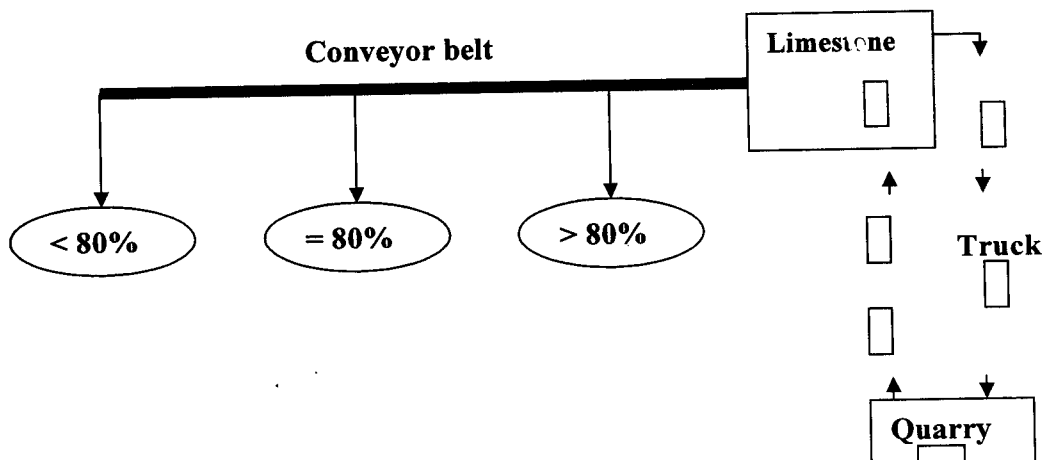

## Supply chain for Raw Material

### LOADING OF LIMESTONE

Quantity of limestone required per year	= 1323855 tons
Quantity of limestone required per day	= 1323855/365 = 3627 tons
Number of stoppage days	= 10 approx.
Exact quantity of limestone required per year	= 1323855- (10 * 3627) = 1287585 tons
Exact quantity of limestone required per day	= 1287585/365 = 3527.6 tons

### TRANSPORTING LIMESTONE FROM QUARRY TO CEMENT PLANT

Number of trucks used for transporting	= 15
Capacity of single truck	= 10 tons
Number of times trucks exploited	= 3527.6/ (15 * 10) = 24
Distance between quarry and plant	= 20 kilometers.
Loading and unloading time of trucks	= 10 minutes
Transporting time of trucks	= 15 minutes

Total work in progress time = 10 + 15 = 25 minutes

## **UNLOADING OF LIMESTONE**

Exact working time = 25 \* 24  
= 600 minutes  
= 10 hours

Thus by this approach, the conveyor switching cost and waiting time of trucks get minimized to great extent.

## **TIME BASED INTEGRATION OF SCM**

Arrival rate of 80% grade (acceptable grade) limestone	= 70%
Arrival rate of less than 80% grade (lower grade) limestone	= 14%
Arrival rate of 80% grade (higher grade) limestone	= 16%
Quantity of acceptable grade limestone	= 2470 tons / day
Quantity of lower grade limestone	= 494 tons / day
Number of days required to accomplish a full day target	= 3527.6 / 494 = 7
Quantity of higher grade limestone	= 564.5 tons / day
Number of days required to accomplish a full day target	= 3527.6 / 564.5 = 6

Therefore the supplying of higher grade limestone is carried out for every 6 days interval and supplying of lower grade limestone is carried out for every 7 days interval.

### 4.2 GANTT CHART FOR LOADING AND UNLOADING LIMESTONE

1 2 3 4 5 6 7 8 9 0 1 2 3 4 5 6 7 8 9 0 1 2

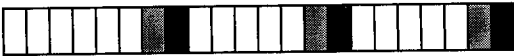

- Acceptable grade limestone loading days
- Higher grade limestone loading days
- Lower grade limestone loading days

Thus the implementation of SCM has reduced the cost for the organization because it reduces lost time, increases productivity of supplying and manpower, and improves market share.

### 4.5.3 AREA 3 – INTERNAL LOGISTICS

**LOGISTICS:** Logistics Management is that part of the supply chain which plans, implements and controls the efficient, effective forward and reverse flow and storage of goods, services and related information between the point of origin and the point of consumption in order to meet customers' requirements. The term is used for describing logistic processes within an industry. The purpose of production logistics is to ensure that each machine and workstation is being fed with the right product in the right quantity and quality at the right point in time. The issue is not the transportation itself, but to streamline and control the flow through the value adding processes and eliminates non-value adding ones.

**LOGISTICS IN MCL:** The limestone from the quarry is separated according to grade (<80%, >80% and 80%) and then it is subjected to undergone a quality test, to check whether the quality is suitable for further processing. The present mode of testing is by, the limestone when enter in to the Electro Static Precipitator (ESP) the office boy from the quality testing department collect a spoon of pulverized limestone and deliver it to quality testing department for every one hour. In that department it is tested and conveys its quality to chemist, if the quality or its ingredients is not up to the level. The chemist will add those ingredients to make it to proceed on further operations.

**PRESENT APPROACH:** The problem present in this process is that, the powdered limestone is stayed in ESP until the testing gets over (4 minutes). If the quality conceded it is subjected to next process. Other wise it is subjected to chemical amalgamation until it reach the concede level. This process consumed up to 4-6 minutes. Therefore total time the limestone is kept waiting during the testing time is revolutionize from 4 to 10 minutes for every hour.

Time consumed by testing process = 4 minutes

Time consumed by amalgamation process = 6 minutes

Total time consumption = 10 minutes

**SCM APPROACH:** Instead of that, we shall arrange a storey or small storage tank before the ESP stage, in which the limestone are sited and during the waiting time the pulverized limestone is subjected to testing, and in the same period the ingredients for amalgamation are kept ready for quick processing. It shall minimize the waiting time from 10 minutes to 2 minutes.



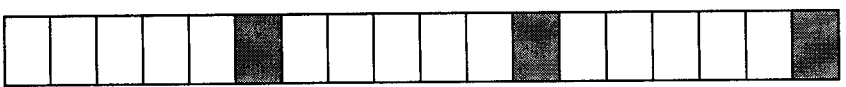

Time consumed by testing process = 0 minutes  
Time consumed by amalgamation process = 2 minutes  
Total time consumption = 2 minutes

**4.3 GANTT CHART FOR INTERNAL LOGISTICS:**

10 20 30 40 50 60 10 20 30 40 50 60 10 20 30 40 50 60 minutes



 - Storing time and time for preparing amalgamation ingredients.

     
2 4 6 8 10 minutes

 - Time required for transmitting and loading.

 - Time required for preparing ingredients for amalgamation.

 - Time required for preparing the material to pass over.

**BENEFITS**

Time consumption for this process is reduced from 10 minutes/hour to 2 minutes/hour. Since it is a continuous process the time saving per year comes around 48 days.

#### **4.5.4 AREA 4- QUALITY TESTING**

##### **QUALITY TESTING:**

MCL has the X-Ray analyzer, is designed to meet the needs of XRF analysis in the cement industry. It is reliable in dusty environments and has a small footprint. As such, it is the ideal stable and flexible spectrometer for demanding applications such as the control of:

- raw mix, from the blending to the frequently monitored kiln feed
- clinker, especially the component and the halogen cycle in the kiln
- cement during the final blending and dispatch
- deliveries from the quarry
- incoming goods (raw materials and fuels)
- special applications like lubrication analysis, alternative fuels or trace element analysis in alternative fuels and raw materials

##### **PRESENT APPROACH:**

The X-Ray analyzer is specially used for three purposes, to check the Raw mix (ingredients to lime stone), clinker and cement during dispatch. The limestone is tested for every one hour, clinker and cement is tested on the basis of quantity. That is, for every 150 tons the components are sending to quality testing. This approach led to wait the components, because sometimes all the materials are hold on a particular time.

##### **SCM APPROACH:**

Instead of bringing the clinker and cement by quantity basis, we shall bring the component on the basis of time. The raw mix for ESP is tested for every one hour. By



corresponding to this, the clinker and cement is tested according to it, to avoid the waiting time and idle time of machine.

**4.2 QUALITY TESTING**

	<b>Lime stone</b>	<b>Clinker</b>	<b>Cement</b>
<b>Testing</b>	5	5	5
<b>Eradicating</b>	3	3	4
<b>Informing</b>	2	2	2
<b>Report framing</b>	7	7	7
<b>Total</b>	17	17	18
<b>Time required for filing</b>	6	<b>Time required for correction if any</b>	2

	<b>Lime stone</b>	<b>Clinker</b>	<b>Cement</b>	<b>Filing</b>	<b>Correction</b>
<b>Total time</b>	17	17	18	6	2

### 4.4 QUALITY TESTING

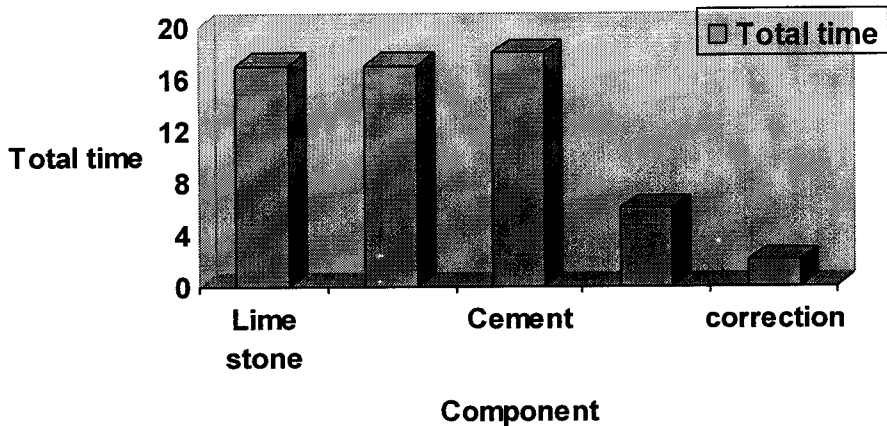

Total time = 17 + 17 + 18 + 6 + 2 = 60 minutes

### 4.5 GANTT CHART FOR QUALITY TESTING:

*Processing time*

*component*

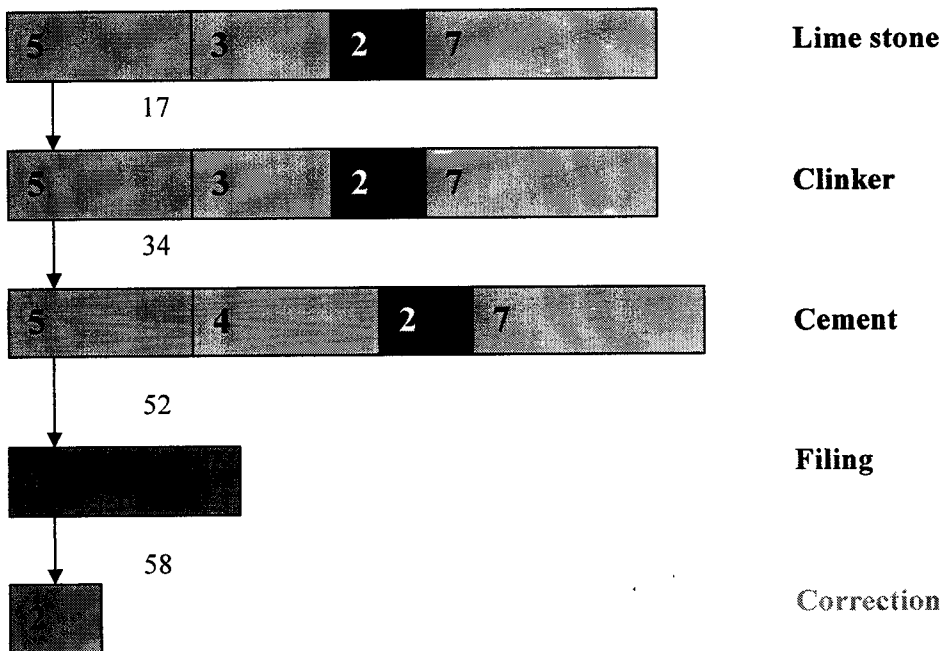

**BENEFITS:** The testing time is shared into five frames such as, limestone, clinker, cement (testing and eradicating), informing the testing results and report framing. It leads to continuous loading, for extra speed of analysis and analytical performance. In terms of production, we just implement the process of changing the Q system view to P system view.

#### **4.5.5 AREA 5-LOADING CEMENT**

##### **CEMENT DISTRIBUTION**

Distribution of cement from ware house to the agents is done in conventional mode that is by transporting the required cement bags to the required place through many trucks or vehicles, this system increases the customer waiting time and transportation cost. Instead of this method, we shall supply the goods to required place by milk run system or by forecasting the each agency demand and transported their goods in a single transportation mode.

Many factors cannot be predicated posing problems in proper SCM implementation. In the present approach the cement is loaded in to the trucks by continuous process. This type of loading will lead to many problems.

An example is the loading of cement into the vessel when it rains. If it rains at the point of loading of cement into the vessel, it will delay the loading process and affect the schedule of the next loading. The product will get to the market late and opportunities will be lost. Another factor in the delivery process is the limitation of equipment to support the transportation of cement along the supply channel.

Quantity of cement produced per year	= 1315450 tons
Number of operating days	= 365
Quantity of cement produced per day	= 1315450 / 365
	= 3604 tons
Capacity of distributing trucks	= 10 tons
Number of trucks dispatched per day	= 360 approx.

## **PRESENT LOADING STRATEGY**

The present system of loading trucks to distribute the cement is done on the basis of continuous operation.

Loading time of each truck = 4 minutes

Total loading time =  $360 * 4$   
= 1440 minutes  
= 24 hours

## **SCM APPROACH**

The integration of supply chain results to parallel operation of loading. According to the manpower, space and availability of trucks may provide the efficient result by this approach.

Possible number of trucks can load in parallel = 6

Maximum loading time of each phase of loading = 10 minutes

Operating time =  $(360/6) * 10$   
= 600 minutes  
= 10 hours

Reduction in time = 14 hours / day

This time based integration can be adjusted to any sequence of timings. If it rains at the point of loading of cement into the vessel, it will not delay the loading process and it does not affect the schedule of the next loading, because the loading can adjusted in order to the next schedule.

## **4.5.6 AREA 6-LOCAL DISTRIBUTING SYSTEM**

### **LOCAL DISTRIBUTING SYSTEM**

**PRESENT APPROACH:** In the south Kerala and south TamilNadu market, previously, the product for this market was supplied directly from the factory to the retailer in collaboration with the distributor.

**SCM APPROACH:** In order to be able to supply the request to that area, a buffer stock warehouse is required. Collaborating with a third party, the company sent the product to the buffer stock warehouse by trucks. That third party manages the product in the buffer stock warehouse. When there is a request from the buyer/retailer, the product can be delivered by that third party quickly, cutting down the delivery time to just 1-2 hours after the order was placed. Whereas before, it took 1-2 days after the order was placed for the product to be delivered. The same activity is now performed in the other market areas. It is expected that the implementation of SCM will increase the market share because the logistics network of the product has become stronger.

In a traditional approach, among the first tasks of a project manager is to identify all the activities in the project, together with their independence and the order in which they must be done. Following, estimates regarding times and costs are made, and the network of activities is build.

In the proposed approach, the project agent, through its network builder agent, behaves in a similar way, but having a supply point of view, instead of building the network of activities based on their timings, a network based on the location where each activity is to be performed will be built. Figure 3 shows a simplified location-based network.

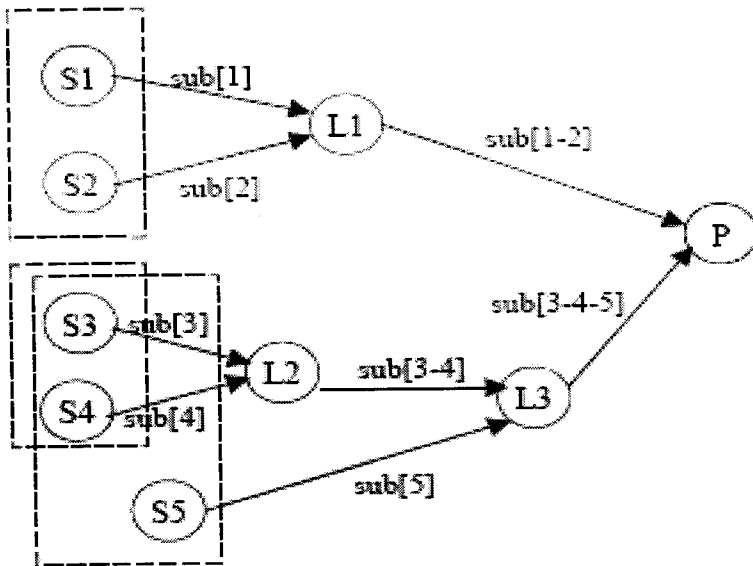

Figure 3: Simplified location-based network

S1...Sn represents the locations of the different supplier sites, where the activities are to be taken place.

L1...Ln symbolize the location of the logistic service provider companies.

P represents the project site.

Sub [1]... [n] = suborders.

Sub [i-...j]... = merged suborders.

The arrows do not represent the distance, just the direction of the material flow (suppliers->consolidation point->project site). Naturally, the real supply networks for large project deliveries are a lot larger than the simplified example in the figure, this being the reasons of so many concerns. When the suborders are not merged, a higher number of logistic service providers (involving higher costs) need to be contracted and a higher number of deliveries need to be handled and kept in inventory at the project site.

**PRESENT APPROACH:** In the south Kerala market, previously, the product for this market was supplied directly from the factory to the retailer in collaboration with the distributor. The present problem by this approach is that, if any retailer or distributor requires lower quantity of cement. We will not be able to supply cement only for them,

because the cement is supplied once in a month or after receiving order up to the convenience level for supply.

**SCM APPROACH:** In order to be able to supply the request to that area, a buffer stock warehouse is required. Collaborating with a third party, the company sent the product to the buffer stock warehouse by trucks. That third party manages the product in the buffer stock warehouse. When there is a request from the buyer/retailer, the product can be delivered by that third party quickly, cutting down the delivery time to just 1-2 hours after the order was placed. Whereas before, it took 1-2 days after the order was placed for the product to be delivered. The same activity is now performed in the other market areas. It is expected that the implementation of SCM will increase the market share because the logistics network of the product has become stronger.

**BENEFITS:** It is easy to supply the finished cement to distributor and retailer in accurate time, when they require for sales. It also indirectly supports the concept of First in First out (FIFO).

#### **4.5.7 AREA 7-INTERLINKING DISTRIBUTION**

**PRESENT APPROACH:** The customers of the MCL are not interlinked with their delivering process. The whole supplying process is carried out by their own mode of distribution, if any distributor wants only less quantity of cement, it is necessary to deliver in time and cost, which concurs both suppliers and distributors.

**SCM APPROACH:** The solution to this problem previously mentioned is seen to come from the combination of automatic identification and merge-in-transit (MIT) techniques. Furthermore, even better results are expected from the introduction of the two techniques in an agent-based environment. Figure 9 illustrates the proposed approach for managing project deliveries in transit.

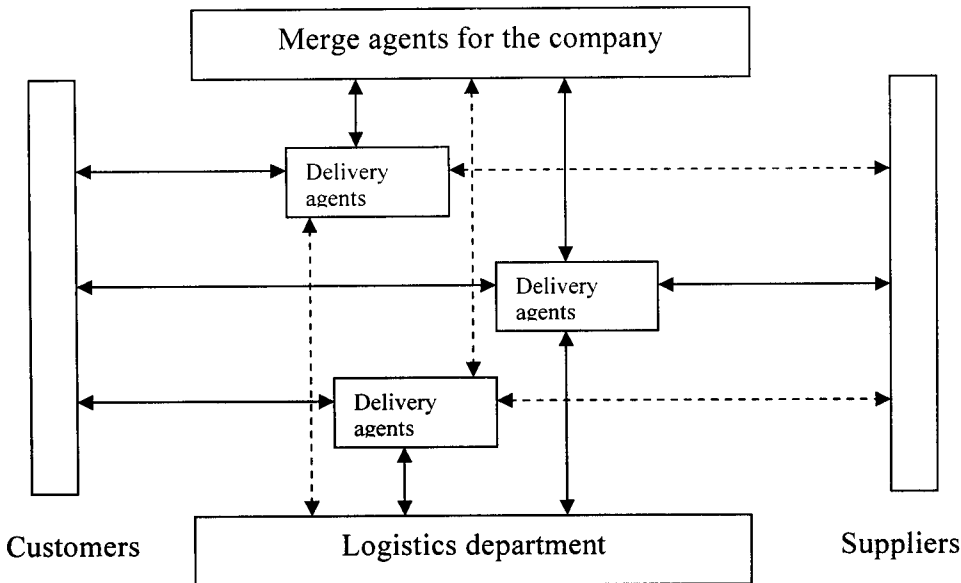

The basis for the proposed solution is that each delivery and each project site has a software-application that is uniquely responsible for the information collection and control of the individual delivery or project site. In other words, each delivery and each project has an individual software-application, or software agent. The proposed concept requires that the deliveries and perhaps some of their components are equipped with identification tags (note that both RFID and barcodes can be used), which links the delivery or component to the Internet location where the relevant data about them are stored, and to the software application responsible for controlling the delivery

#### 4.5.8 AREA 8- MILK RUN SYSTEM IN DISTRIBUTION

**PRESENT APPROACH:** The cement distribution to a particular area, which comprises of many towns and cities, where the requirement of cement is copious. It is necessary to supply the precise quantity specified by the dealers in that area. If their requirements are in intermediary range, it cause transport wastages by distributing the required cement in semi loaded trucks.



**SCM APPROACH:** This approach helps to deal this problem in non expensive manner. By the above interlinking, the distribution is carried out by milk run distribution. For better understanding consider the example given below.

Let

D1 and D2 are the distribution centers.

R1, R2, R3 and R4 are the requirements of cement in A1, A2, A3 and A4 areas.

### 4.3 MILK RUN DISTRIBUTION

	R1=15000 in tons	R2=25000 in tons	R3=16000 in tons	R4=20000 in tons				
D1	50	60	80	40				
D2	40	80	50	60				
A4	<b>15</b>	A1	<b>30</b>	A2	<b>40</b>	A3	<b>60</b>	A1

Let **15, 30, 40** and **60** be the distance from *A4-A1, A1-A2, A2-A3 and A3-A4* respectively. Let the capacity of trucks is 10 tons.

The requirement of cement in area A1 is 15000 tons; it requires 2 trucks to deliver its quantity, but the second truck carries the cement in semi loaded mode. For the remedy by considering the next nearest area A2, it requires 25000 tons. By the interlinking, transporting the same truck which delivers the cement in area A1 is redirected to the area A2, which is just 30 kilometers from the previous one. By this redirecting, the hiring charge for one more truck to deliver the cement separately gets minimized. But for the area 3, it requires 16000 tons cement, and there is no possibility for redirecting the truck from other dealers.

This approach is either done by distance evaluation or by transport cost evaluation. But the profit for the both is evolving in terms of cost minimization. By assimilating this approach with Merge-in-transit (MIT) techniques, the results for this transporting problem get minimized to great extent.

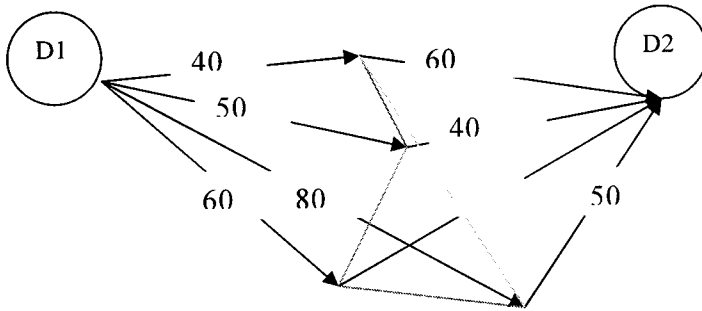

- $\dashrightarrow$  Distance between the two areas.
- $\longrightarrow$  15 kilometers, from area (A4) to area (A1).
- $\longrightarrow$  30 kilometers, from area (A1) to area (A2).
- $\longrightarrow$  40 kilometers, from area (A2) to area (A3).
- $\dashrightarrow$  60 kilometers, from area (A3) to area (A4).

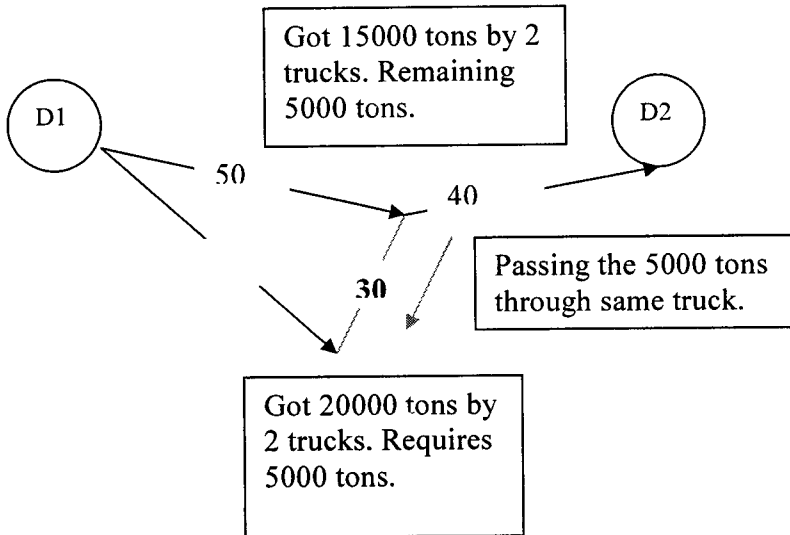

#### **4.5.9 AREA 9 - JUST IN TIME - SCM FOR READY MIX CONCRETE**

This project focuses on the ready-mixed concrete delivery: in addition to the mentioned complexity, strict time-constraints forbid both earliness and lateness of the supply. The term Just-In-Time (JIT), used for instance to describe the delivery of materials to a construction site, suggests that materials will be brought to their location for final installation and be installed immediately upon arrival without incurring any delay due to storage in a lay down or performance area. The ultimate objective of JIT production is to supply the right materials at the right time and in the right amount at every step in the process.

#### **BATCH PROCESS**

Ready-mix concrete is a prototypical example of a batch process, where a customer process (the contractor) releases an order to batch to the supplying process (the batch plant) and receives product as a result. This batch process does not allow any inventory of product to be maintained because the product is perishable.

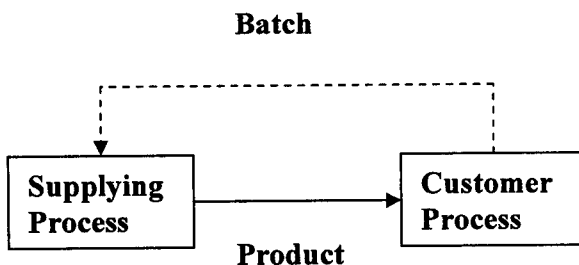

#### **CONCRETE PRODUCTION SYSTEM**

The production system for concrete is governed by the plant operator's equipment, the contractor's placement method, and of course, their individual schedules as well as the coordination of those schedules between them.

**Batch Plants have Limited Capacity:** A batch plant's capacity is determined by either batching capacity or delivery capacity.

**Batching Capacity:** is determined by the time needed to measure, dispense, and mix ingredients, then load them into a truck.

**Delivery Capacity:** is determined by the number of trucks and drivers that service the batch plant. Batch plants may also load concrete into pickup- or revolving drum trucks owned by a third party.

**Placement Size:** Large placements require uninterrupted supply of concrete in order to avoid unplanned construction joints. A delivery sequence for uninterrupted supply at a site may require a loaded truck to always be on standby for concrete to be available when the preceding truck has been emptied.

**Total Quantity Ordered of a Specific Mix:** Raw materials for the batch plant (aggregates and cement) are typically restocked daily. Extra deliveries can be arranged if the need so dictates. Materials are loaded into computer controlled bins that feed scales, emptying onto conveyor belts that lead to the mixer. Excess sands and gravels may be stored in open-air compartments, often located at the perimeter of the plant and moved with a loader to conveyors that get them into the bins when needed.

**Model Delivery Cycle and Location:** Since concrete should be placed no later than ninety minutes after the addition of water, travel from the batch plant to a site should not take much more than half an hour or so.

**Contractor ordering and Timing of Delivery:** As noted, the contractor must plan and prepare for the arrival of the concrete. When a contractor calls for a concrete delivery, he needs to be ready to place that concrete once it arrives. However, same day orders for delivery at a specific time can seldom be guaranteed by a plant due to limited delivery capacity.

## **ADVANTAGE OF READY-MIX CONCRETE OVER SITE MIX CONCRETE:**

- Better quality concrete is produced.
- Elimination of storage space for basic materials at site.
- Elimination of Procurement / Hiring of plant and machinery
- Wastage of basic materials is avoided.
- Labor associated with production of concrete is eliminated.
- Time required is greatly reduced.
- Noise and dust pollution at site is reduced.
- Organization at site is more streamlined.

## **READY-MIXED CONCRETE SUPPLY CHAIN**

First of all, it should be mentioned that once the production center adds water to the mix of dry materials, the concrete has only about two hours before the hydration process forms a gel that, if disrupted, would compromise the ultimate strength of the concrete. Thus, large orders require a strictly uninterrupted supply of concrete in order to avoid dangerous construction joints.

### **DELIVERY SEQUENCE**

A delivery sequence for uninterrupted supply at a site requires a loaded truck to be available at the site when the preceding truck has ended the unloading. In some circumstances, there can be extremely large orders that involve a considerable number of trucks and thus tie up most of production plant's and vehicle fleet's capacity. Since concrete should be placed no later than two hours after the addition of water, travel from the batch plant to a site should not take much more than an hour or so. Therefore, a plant's operating radius tends to be limited based on the nature and condition of haul roads. The time a ready-mix truck may sit in traffic during rush hours is a significant consideration when scheduling site deliveries. On-time delivery of concrete is essential to a customer. If a truck arrives early, the concrete placement crew may not yet be ready. If a truck arrives late the continuity of unload is violated, and if the delay exceeds the concrete setting time the entire load has to be disposed.

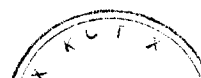

# CONCRETE BATCHING AND DELIVERY BY READY-MIX PLANT

Four major players (the design engineer, the ready-mix batch plant, the raw material provider, and the contractor) are identified together with the processes they perform. The batch plant owns a batching facility as well as a fleet of revolving-drum trucks. Based on a schedule with contractor orders, the plant prepares the mix one truckload at a time and then promptly delivers it to the appropriate site for placement of the concrete.

## BATCHING AND DELIVERY BY READY-MIX PLANT

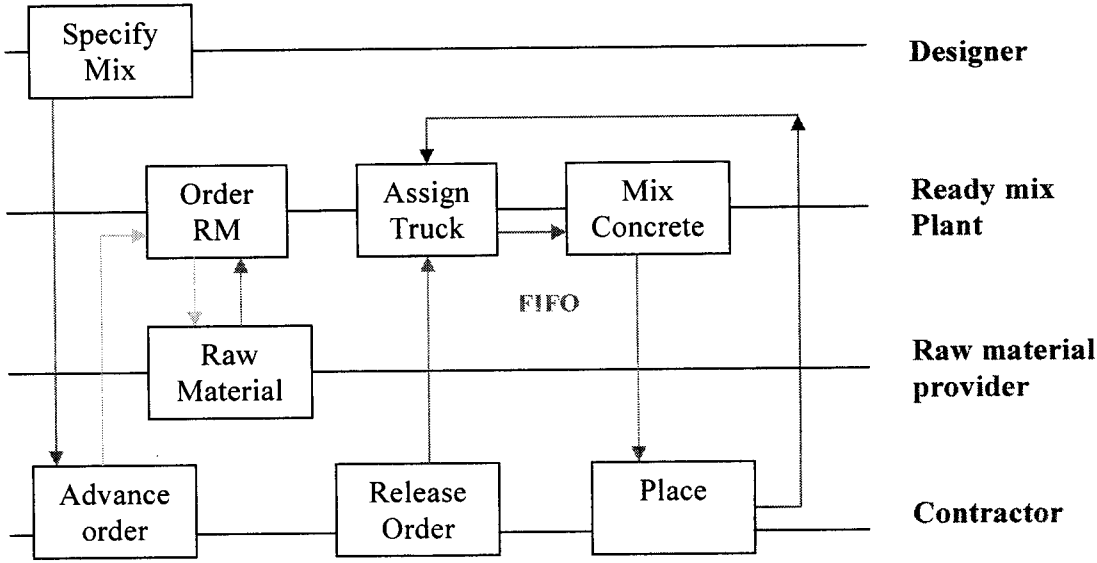

- Loaded truck to deliver ready mix concrete
- Unloaded truck or kanban signal to plant
- Signal for inventory status and delivery of raw material
- Signal to order raw material
- Procuring of raw material
- Assigning return trucks to proceeding orders
- Notation for specify concrete mix

## **KANBAN DESIGN**

Designers (line I) specify concrete mixes either by recipe or performance. They spell out the requirements in construction documents that are subsequently made available to contractors, e.g., as part of the bid documents. The contractor (line IV) draws information from those specifications when taking off concrete quantities on a project-by-project basis. The contractor also decides on placement sizes and methods. In order to or after identifying the ready-mix plant that will supply the concrete, the contractor then schedules advance orders with approximate quantities and delivery times with the plant. This way, plant capacity will be reserved on the day(s) needed. Doing so is especially critical during busy times of the week and when a large order is being placed that requires uninterrupted delivery so that multiple trucks will have to be synchronized.

The batch plant (line II) uses the advance order for its raw materials inventory planning. Especially mixes that require special aggregates or additives must be ordered with a lead time from suppliers (line III) for the plant to be able to order and receive those special items by the time batching is to take place. Water is considered to be a material

'in stock' but is not shown here as a separate ingredient for the batching process. A few days up to a day prior to batching, the contractor (line IV) must call in a release order to the batch plant (line II) to confirm the previously-agreed delivery of concrete at the specified time of the specified day. More often than not, the contractor will ask for some modification to the order on record because project conditions will by then have changed relative to what had been anticipated at the time of the advance order.

Ready-mix production exemplifies a pull system because concrete is batched upon demand only. The contractor's release order conveys the pull, except that the batch plant ultimately determines the actual timing of contractor-ordered batch. Ready-mix batch plants prefer to get advance orders but in any case need the contractor to call in a release order so they can schedule a time slot for delivery, then assign a truck and driver, prepare and load the mix, and ship it to the project site shortly before the requested delivery time.

## **BENEFITS**

In this work, we considered the problem of finding an optimized schedule for the just-in-time production and delivery of raw material and finished cement bags on a set of distributed and coordinated production centers. Our attention was firstly focused on the development of a complete and detailed deterministic model of the considered supply chain, incorporating all the specifics that make it considerably different from other formulations of similar scheduling and routing problems. In a subsequent step, we described an effective scheduling algorithm based on the proposed model, i.e., by the integration of various cost minimizing processes.



**CHAPTER-5**

**CONCLUSION**

## CHAPTER -5

### CONCLUSION

#### 5.1 FINDINGS:

- The Logistics costs in India is estimated to be 13% of GDP, which is Rupees 4,226.21 billion in 2005-06, compared to less than 10% of GDP in industry manufacturing activities including distribution, warehousing, and inventory. Global averages of logistics cost are around 9%. This lagging is because of 90% of Indian logistics are depends on road transport, where as in developed countries, they spread their logistics cost evenly around waterways, rail routes, airways and roadways.
- MCL mainly focused on updating production technology, rather than process technology.
- The customers of the MCL are not interlinked with their delivering process, because of heavy competitions between the competitors.
- Indian Government's proposed Value Added Tax (VAT), a uniform tax regime, is expected to drive Madras Cements Limited towards using more 3PL services in future.
- Likewise, lack of sufficient warehousing and specialized storage facilities beyond major cities like Trivandrum, Marthandam e.t.c., of the country is another major challenge.
- The logistics cost of cement is widely spread in transport, inventories, losses, packaging, ware housing and customer shopping.

#### 5.1 DISTRIBUTION OF LOGISTICS COST

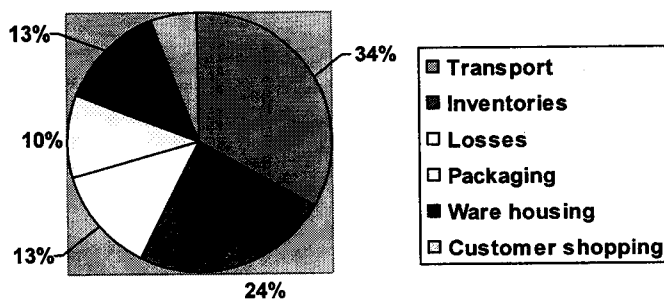

- Most of the time was mainly spent in loading and unloading the material.
- Continuous utilization of labor resources makes the process slow.
- Yet it is a continuous production process, the custom of doing things in P system is more effective than Q system.
- It is desirable to have redundant quantity of components in manufacturing process and distribution systems. This redundancy increases production when all systems are operational and allows individual equipment within the process to be serviced or avoided as needed without complete stopping the entire production process.
- Since cement manufacturing is a continuous process with sequential operations, there is also a possibility of going for concurrent process in some areas.
- All the operations held in cement plant is interlinked and governed by central control room, so impulsive modification of process is not easy.
- Educating the labors will improve the efficiency by react themselves for any sudden happenings.
- Going for lend truckers for supplying the finished cement to the nearest areas is much expensive than owning the truckers.
- Automation of process will lead to cost minimization and time minimization.
- 90 % of work stoppages are due to unexpected power failure.
- Conveyor plays the important role in internal logistics. So, it is essential to arrange a sub conveyor to avoid stoppages during unexpected failure.
- Inter implementing technical machines functions are not clearly planned.
- Raw material statuses are informed to stores and marketing department by periodic system that is on 5 p.m everyday. Instead of this, going for quantity based information will lead to prevent shortage.
- Present trends indicate that the cement sector has reaped the maximum benefits by outsourcing logistics requirements to 3PLs, especially as logistics constitute between 10% and 15% of their operating costs
- The logistics market is likely to grow at a CAGR of 7% during the next five years. Chemicals, metals, FMCG, cement and textiles have been identified as the top five contributors to logistics revenues.

## **5.2 SUGGESTIONS:**

Cement is a functional product. To win market share, it needs to adopt the cost leadership strategy, which requires it to be efficient in its processes. Besides using cost leadership strategy, the availability of cement in the market and the proximity of the product to its consumers are major factors to gain competitiveness. The SCM concept is a tool to achieve efficiency and productivity, and to increase market size through synchronization of activities along the supply chain. A supply chain that has the commitment of the various departments in the organization as well as the full support of external organizations along the chain will create a super chain that will result in higher productivity, reduce costs and improve customer service and loyalty.

This paper focused on the SCM of the Cement raw materials from the suppliers and mines to the cement plant, semi finished product cement and finished product cement from the factory to the market/end users. However, the implementation of SCM is not without barriers such as different visions of the organizations involved in the supply chain, unpredictable processes of SCM, no uniform implementation of IT by different organizations, and the people who carry out the SCM processes. These barriers have influenced the successful implementation of SCM.

After analyzing the findings of the “Logistics / Supply Chain Management, it becomes increasingly apparent that competition is more global and that innovation is moving from a firm-to-firm level to a supply chain versus supply chain perspective. Logistics and SCM is thus becoming a key industrial sector as well as an enabler for innovation, competitiveness and commercialization of technology and processes across all industrial sectors.

### **5.3 FUTURE IMPLEMENTATIONS IN MCL:**

- MCL group companies are looking to use RFID to track goods within their supply chain and automate processes. A benefit of RFID in logistics is that it can also reduce costs and wastage within the supply chain. Costs are lowered as the increased visibility of products through the supply chain helps reduce shrinkage and errors. Savings can be achieved from the removal of manual processes due to automated scanning of assets, rather than the manual scanning of bar codes.
- Companies are looking forward to assemble a combination of in-house and outsourced service components to effectively manage their supply chains.
- Interlinking all the operations, cement mill, coal mill, kiln, ESP, pre heater, quality circle, packing and distributing for effectively transporting only required quantity of components from one place to another, and to minimize the inventory and process time.
- Information regarding to operations and distribution are transferring through voice and phone calls, because of the industrial noises, it is not effective. So, MCL plans to change this system in to signal, alarm and instruction card.
- MCL plans to integrate their customers through information technology, which helps to know the day to day market situation in all areas and for effective distribution and transportation of goods and information.



## **BIBLIOGRAPHY**

### **REFERENCES:**

1. Sridhar Tayur, Ram Ganeshan, Michael Magazine (editors). Quantitative Models for Supply Chain Management. Kluwer Academic Publishers, 1999.
2. R.B. Handfield and E.L. Nichols, Jr. Introduction to Supply Chain Management. Prentice Hall, 1999
3. Y. Narahari and S. Biswas. *Supply Chain Management: Models and Decision Making*  
Ram Ganeshan and Terry P. Harrison. *An Introduction to Supply Chain Management*
4. D. Connors, D. An, S. Buckley, G. Feigin, R. Jayaraman, A. Levas, N. Nayak, R. Petrakian, R. Srinivasan. *Dynamic modelling for business process reengineering*. IBM Research Report 19944, 1995

### **WEBSITES:**

- [www.supplychainmetric.com](http://www.supplychainmetric.com)
- [www.logisticsworld.com](http://www.logisticsworld.com)
- [www.scmr.com](http://www.scmr.com)